

REV	BY	DESCRIPTION	DATE
-----	----	-------------	------

ITEM	PART #	DESCRIPTION	QTY.
1	MF3060-3	HEAVY DUTY 3-SECTOR 30" TO 60" POLE RING MOUNT (ITEM 2-8)	1
2	MF3060-3.01	FLUSH MOUNT RING MOUNT 30" TO 60" O.D.	3
3	27-5588-005	GALV. 3/4" B7 ALL THREAD @ 42" LONG	9
4	27-5480-005	GALV. 3/4" FLAT WASHER	18
5	27-5490-005	GALV. 3/4" LOCK WASHER	18
6	27-5500-005	GALV. 3/4" HEAVY HEX NUT	18
7	27-5440-005	GALV. 5/8" x 2-1/4" A325 BOLT ASSEMBLY	12
8	27-5370-005	GALV. 5/8" FLAT WASHER	12
9	M3015-48	SINGLE SUPPORT ARM 48" LONG	3
10	AM1016-14	14'-6" CELLULAR FACE CROSS OVER MOUNT (ITEM 11-14)	3
11	P35-174	3-1/2" O.D. PIPE x 14'-6" LONG	3
12	AM1016-XP.01	3-1/2" TO 4-1/2" CROSS OVER PLATE	3
13	27-6090-005	GALV. 1/2" x 3-5/8" x 5" U-BOLT ASSEMBLY	12
14	27-6130-005	GALV. 1/2" x 4-5/8" x 6" U-BOLT ASSEMBLY	12

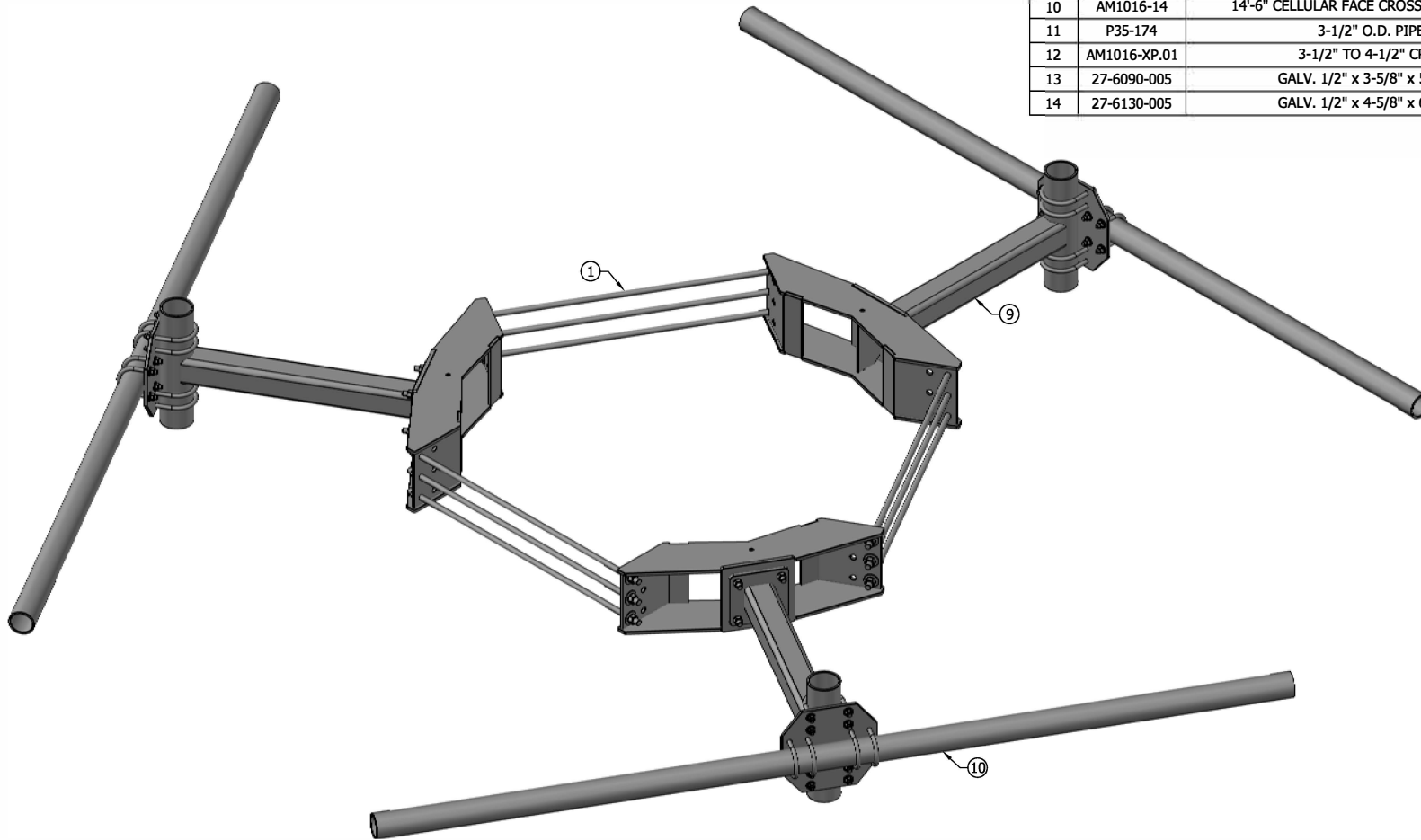

STANDARD TOLERANCES:
(UNLESS OTHERWISE NOTED)

FRACTIONS ±1/16"
DECIMALS ±.005"
ANGLES ±.5°

THE DESIGN AND INFORMATION CONTAINED ON THIS PRINT IS PROPERTY OF VALLEY FAB CORP. ANY REPRODUCTION, DUPLICATION, OR TRANSFER OF THE PROPRIETARY CONTENT IS PROHIBITED WITHOUT WRITTEN PERMISSION.

NEWAVE
Tower Components. 503-792-3739
10910 PORTLAND RD. BROOKS, OR 97305

MATERIAL: AS SHOWN
HOLES: AS SHOWN
FINISH: HDG

DRAWN BY: KY
CHECKED BY: CW
DATE: 01/09/2012

TITLE: 3-SECTOR CO-LOCATION T-ARM FRAME
48" STAND OFF WITH 14'-6" FACE
SERIES: MONOPOLE MOUNTING
PROJECT NO. - DRAWING NO. MRCK3-14-48 SHEET: 1 OF 1