

ITEM	PART #	DESCRIPTION	QTY	UNIT WT
1	M3016-8.01	SINGLE ANTENNA 8" STAND OFF WELDMENT	1	18.32
2	27-5440-005	GALV. 5/8" x 2-1/4" A325 BOLT ASSEMBLY	4	0.31
3	27-5370-005	GALV. 5/8" FLAT WASHER	4	0.07
4	P35-60	GALV. 3" STD PIPE @ 5'-0" LONG	1	37.92
5	27-6090-005	GALV. 1/2" x 3 5/8" x 5" U-BOLT ASSEMBLY	2	0.91

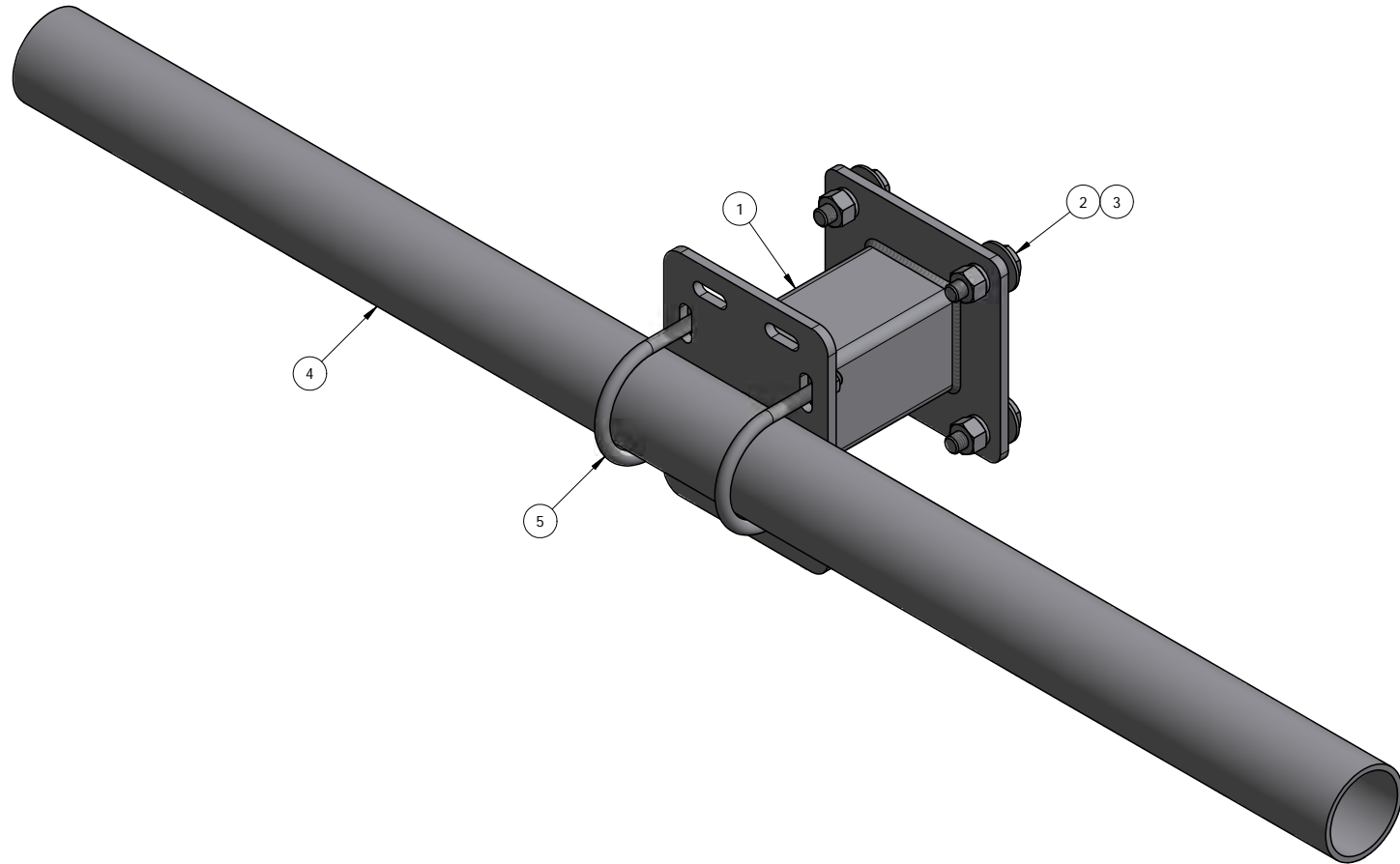

QTY:
CHK:

STANDARD TOLERANCES:
(UNLESS OTHERWISE NOTED)
FRACTIONS ±1/16"
DECIMALS ±.005"
ANGLES ±.5°

THIS DESIGN AND INFORMATION CONTAINED ON THIS PRINT IS THE PROPERTY OF NEWAVE TOWER COMPONENTS LLC. ANY REPRODUCTION, DUPLICATION OR TRANSFER OF THE PROPRIETARY CONTENT IS PROHIBITED WITHOUT WRITTEN PERMISSION.

NEWAVE
TOWER COMPONENTS. 503-792-3739
10910 PORTLAND RD. BROOKS, OR 97305

MATERIAL: AS SHOWN
HOLES: AS SHOWN
FINISH: HDG
DRAWN BY: JG
CHECKED BY: KY
DATE: 1/16/2014

TITLE: DOUBLE ANTENNA SUPPORT ARM
60" FACE W/ 8" STAND OFF
SERIES: MONOPOLE MOUNTING
PART WT (BARE): 60.2 LB
DRAWING NO. M3019-8
SHEET: 1 OF 1