

REV	BY	DESCRIPTION	DATE
A	KY	SEE MODEL I PROPERTIES/ COMMENTS	5/6/2019

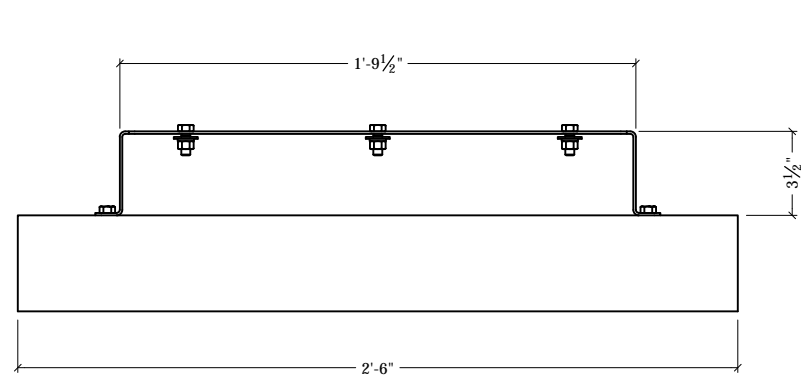

END VIEW

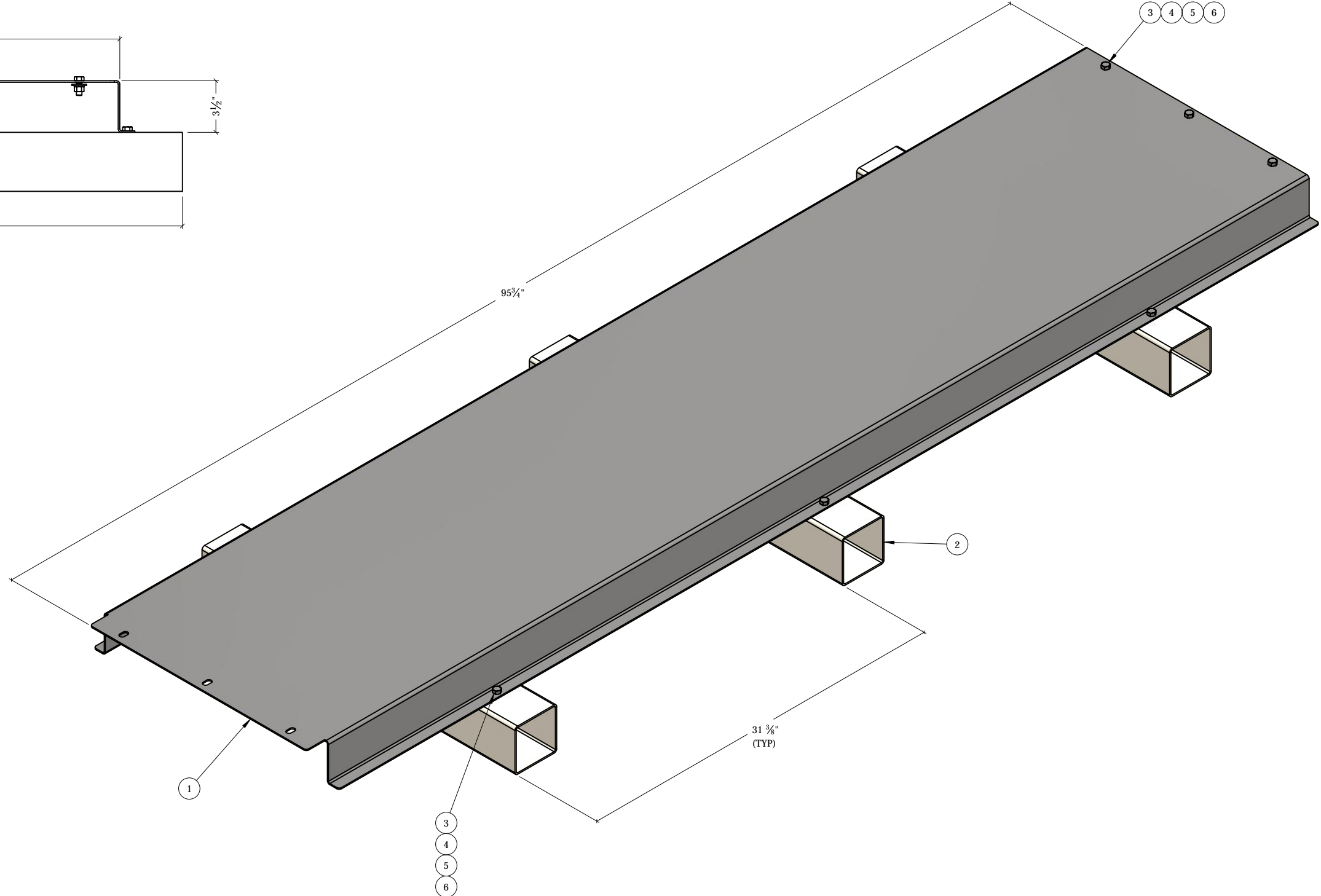

ITEM	PART #	QTY	DESCRIPTION	LENGTH	FINISH	UNIT WT
1	RT1542-8.01	1	12 GA SHEET METAL		PG, G90	84.74
2	CA1600-8	3	HST 4"x4"x1/8"	2'-6"	PVC	2.63
3	27-4200-005	9	3/8" x 1" GR.5 HDG BOLT			0.05
4	27-5010-005	9	3/8 A36 HDG FLAT WASHER			0.01
5	27-5020-005	9	3/8 HDG LOCK WASHER			0.01
6	27-5030-005	9	3/8" HDG HEX NUT			0.02

THIS DESIGN AND INFORMATION CONTAINED ON THIS PRINT IS THE PROPERTY OF VALLEY FAB CORPORATION. ANY REPRODUCTION, DUPLICATION OR TRANSFER OF THE PROPRIETARY CONTENT IS PROHIBITED WITHOUT WRITTEN PERMISSION.

STANDARD TOLERANCES:
(UNLESS OTHERWISE NOTED)
FRACTIONS - 1/16"
DECIMALS - 0.01"
ANGLES - 0.5°

NEWAVE
TOWER COMPONENTS, 503-792-3739
10910 PORTLAND RD. BROOKS, OR 97305

TOTAL WT: 93.45 LB
QTY:
FINISH: AS SHOWN
JOB #:

TITLE: ROOFTOP CABLE COVER, 8' SELF-SPLICE 8-RUN, 3-1/2" TALL, 21-1/2" WIDE		DRAWN BY: KY	DATE: 5/7/2019	CHK'D BY: -
SERIES: ROOFTOP	SHEET: 1 OF 1	DRAWING NO. RT1542-8		