

ITEM	PART #	DESCRIPTION	QTY	UNIT WT
1	WT6001.01	BASE ATTACHMENT WELDMENT	3	9.90
2	WT6001.04	CENTER BASE ATTACHMENT WELDMENT	3	17.08
3	WT6002-14.01	L3x3x1/4" ANGLE, CUT @ 14'-6" LONG	3	71.30
4	WT6002.01	2-7/8" O.D x 8' LONG ANTENNA PIPE LEG WELDMENT	3	49.73
5	WT6002.02	L3x3x1/4" ANGLE, CUT @ 4'-7-1/2" LONG	3	22.73
6	TR58-8	GALV. 5/8" x 8" ALL-THREAD	3	0.69
7	27-4403-005	GALV. 5/8" x 2" GR.5 BOLT	6	0.27
8	27-5380-005	GALV. 5/8" LOCK WASHER	12	0.03
9	27-5391-005	GALV. 5/8" HEX NUT	12	0.08
10	27-6080-005	GALV. 1/2" x 3" x 5" GR-5 U-BOLT ASSEMBLY	9	0.89

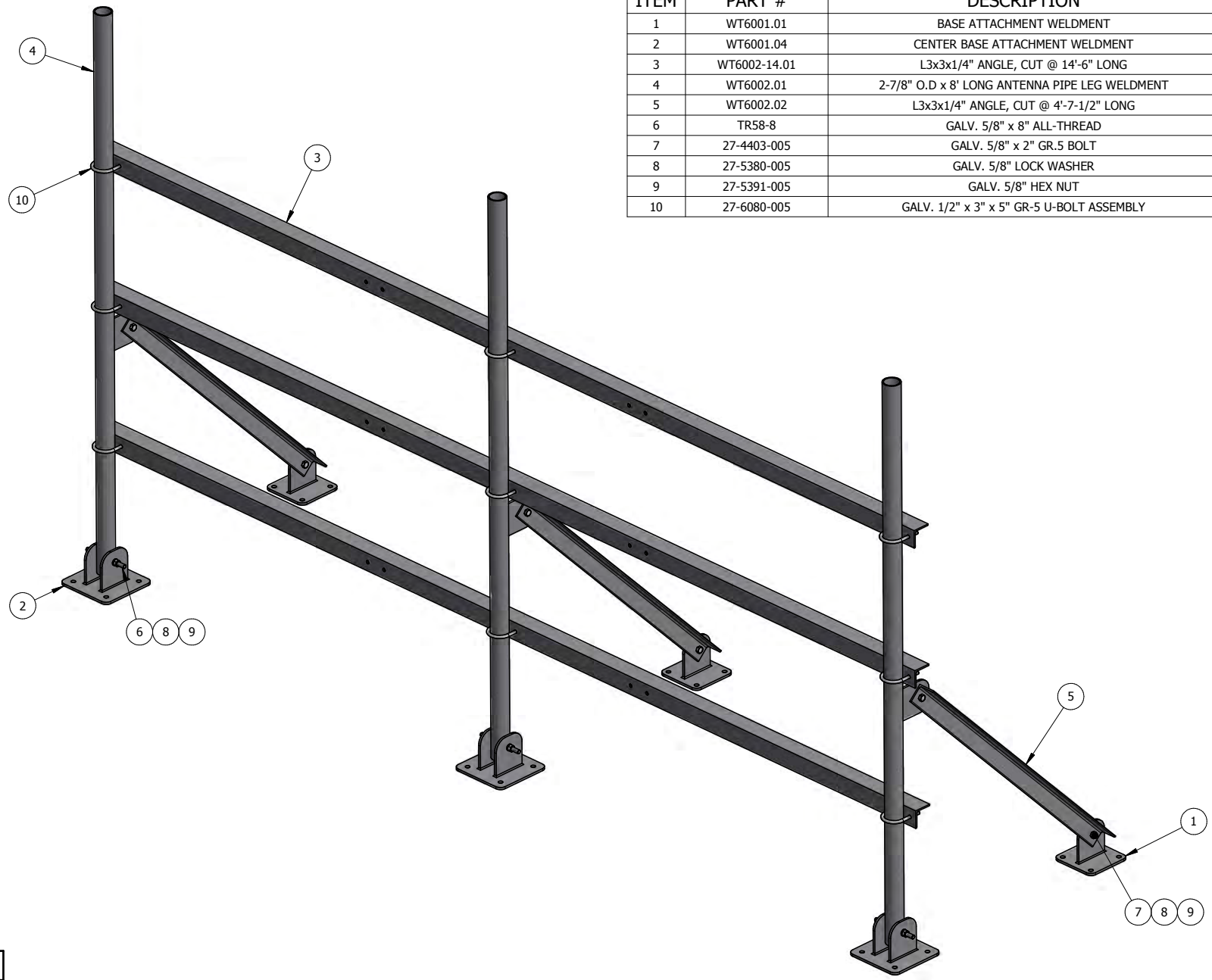

QTY:
CHK:

STANDARD TOLERANCES:
(UNLESS OTHERWISE NOTED)
FRACTIONS ±1/16"
DECIMALS ±.005"
ANGLES ±.5°

THIS DESIGN AND INFORMATION CONTAINED ON THIS PRINT IS THE PROPERTY OF NEWAVE TOWER COMPONENTS LLC. ANY REPRODUCTION, DUPLICATION OR TRANSFER OF THE PROPRIETARY CONTENT IS PROHIBITED WITHOUT WRITTEN PERMISSION.

NEWAVE
Tower Components. 503-792-3739
10910 PORTLAND RD. BROOKS, OR 97305

MATERIAL: AS SHOWN
HOLES: AS SHOWN
FINISH: HDG

DRAWN BY: KY
CHECKED BY:
DATE: 12/2/2016

TITLE: WATER TANK OR ROOFTOP FACE FRAME
W/ 14'-6" FACE AND (3) 2-7/8" O.D x 8' PIPES
SERIES: ROOFTOP MOUNTING
PART WT (BARE): 525.3 LB
DRAWING NO. WT6002-3-14
SHEET: 1 OF 2

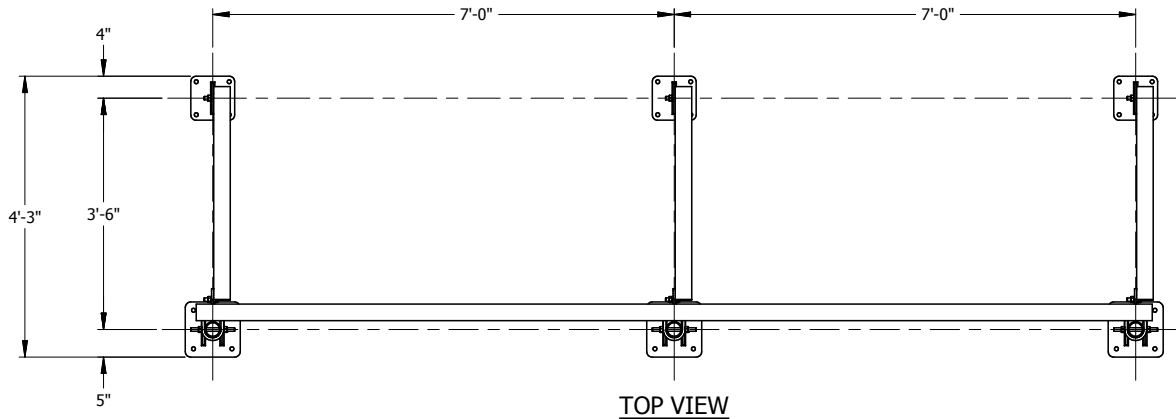

TOP VIEW

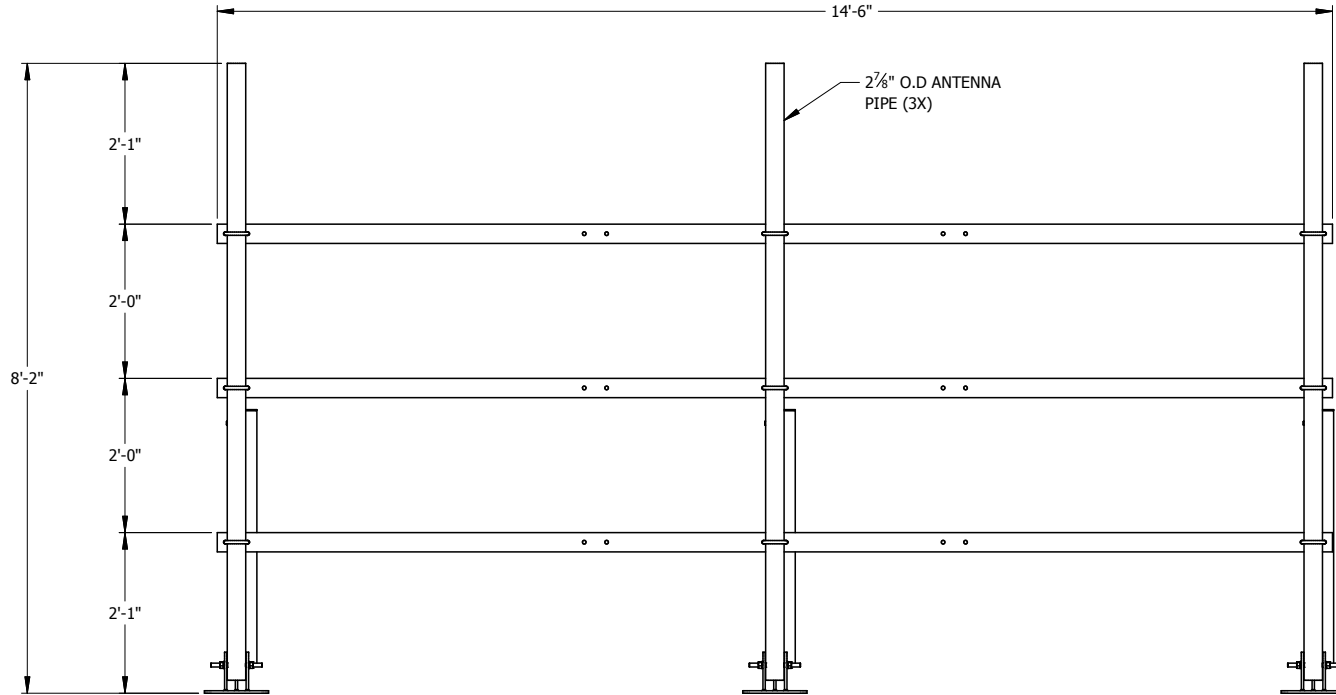

FRONT VIEW

QTY:
CHK:

STANDARD TOLERANCES:
(UNLESS OTHERWISE NOTED)
FRACTIONS ±1/16"
DECIMALS ±.005"
ANGLES ±.5°

THIS DESIGN AND INFORMATION CONTAINED ON THIS PRINT IS THE PROPERTY OF NEWAVE TOWER COMPONENTS LLC. ANY REPRODUCTION, DUPLICATION OR TRANSFER OF THE PROPRIETARY CONTENT IS PROHIBITED WITHOUT WRITTEN PERMISSION.

NEWAVE
TOWER COMPONENTS. 503-792-3739
10910 PORTLAND RD. BROOKS, OR 97305

MATERIAL: AS SHOWN
HOLES: AS SHOWN
FINISH: HDG

DRAWN BY: KY
CHECKED BY:
DATE: 12/2/2016

TITLE: WATER TANK OR ROOFTOP FACE FRAME
W/ 14'-6" FACE AND (3) 2-7/8" O.D x 8' PIPES
SERIES: ROOFTOP MOUNTING
PART WT (BARE): 525.3 LB
DRAWING NO. WT6002-3-14
SHEET: 2 OF 2